

JFET - General Purpose Transistor

N-Channel

MMBF5457LT1

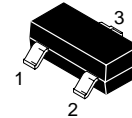

CASE 318-08, STYLE 10
SOT-23 (TO-236AB)

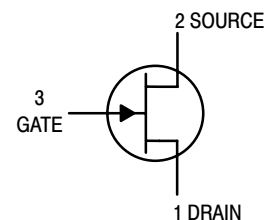

MAXIMUM RATINGS

Rating	Symbol	Value	Unit
Drain-Source Voltage	V_{DS}	25	Vdc
Drain-Gate Voltage	V_{DG}	25	Vdc
Reverse Gate-Source Voltage	$V_{GS(r)}$	25	Vdc
Gate Current	I_G	10	mAdc

THERMAL CHARACTERISTICS

Characteristic	Symbol	Max	Unit
Total Device Dissipation FR-5 Board ⁽¹⁾ $T_A = 25^\circ\text{C}$ Derate above 25°C	P_D	225 1.8	mW mW/°C
Thermal Resistance, Junction to Ambient	$R_{\theta JA}$	556	°C/W
Junction and Storage Temperature	T_J, T_{stg}	-55 to +150	°C

DEVICE MARKING

MMBF5457LT1 = 6D

ELECTRICAL CHARACTERISTICS ($T_A = 25^\circ\text{C}$ unless otherwise noted)

Characteristic	Symbol	Min	Typ	Max	Unit
----------------	--------	-----	-----	-----	------

OFF CHARACTERISTICS

Gate-Source Breakdown Voltage ($I_G = 10 \mu\text{Adc}$, $V_{DS} = 0$)	$V_{(BR)GSS}$	25	-	-	Vdc
Gate Reverse Current ($V_{GS} = 15 \text{Vdc}$, $V_{DS} = 0$) ($V_{GS} = 15 \text{Vdc}$, $V_{DS} = 0$, $T_A = 100^\circ\text{C}$)	I_{GSS}	-	-	1.0 200	nAdc
Gate Source Cutoff Voltage ($V_{DS} = 15 \text{Vdc}$, $I_D = 10 \text{nAdc}$)	$V_{GS(off)}$	0.5	-	-6.0	Vdc
Gate Source Voltage ($V_{DS} = 15 \text{Vdc}$, $I_D = 100 \mu\text{Adc}$)	V_{GS}	-	-2.5	-	Vdc

ON CHARACTERISTICS

Zero-Gate-Voltage Drain Current ⁽²⁾ ($V_{DS} = 15 \text{Vdc}$, $V_{GS} = 0$)	I_{DSS}	1.0	-	5.0	mAdc
---	-----------	-----	---	-----	------

- FR-5 = $1.0 \times 0.75 \times 0.062$ in.
- Pulse Test: Pulse Width ≤ 630 ms, Duty Cycle $\leq 10\%$.

MMBF5457LT1

ELECTRICAL CHARACTERISTICS ($T_A = 25^\circ\text{C}$ unless otherwise noted) (Continued)

Characteristic	Symbol	Min	Typ	Max	Unit
SMALL-SIGNAL CHARACTERISTICS					
Forward Transfer Admittance ⁽²⁾ ($V_{DS} = 15\text{ Vdc}$, $V_{GS} = 0$, $f = 1.0\text{ kHz}$)	$ Y_{fs} $	1000	–	5000	μmhos
Reverse Transfer Admittance ($V_{DS} = 15\text{ Vdc}$, $V_{GS} = 0$, $f = 1.0\text{ kHz}$)	$ Y_{rs} $	–	10	50	μmhos
Input Capacitance ($V_{DS} = 15\text{ Vdc}$, $V_{GS} = 0$, $f = 1.0\text{ MHz}$)	C_{iss}	–	4.5	7.0	pF
Reverse Transfer Capacitance ($V_{DS} = 15\text{ Vdc}$, $V_{GS} = 0$, $f = 1.0\text{ MHz}$)	C_{rss}	–	1.5	3.0	pF

2. Pulse Test: Pulse Width $\leq 630\text{ ms}$, Duty Cycle $\leq 10\%$.

TYPICAL CHARACTERISTICS

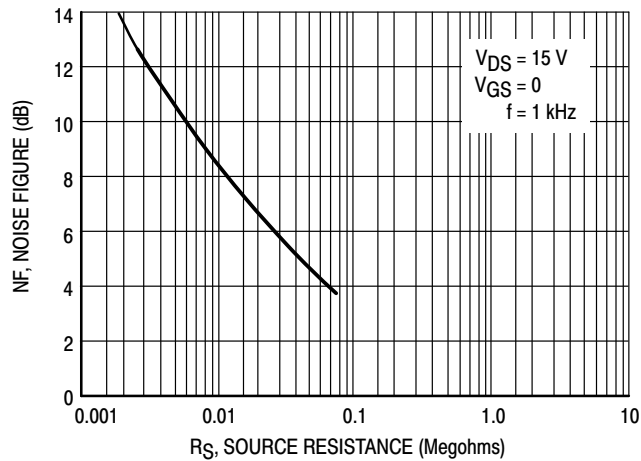

Figure 1. Noise Figure versus Source Resistance

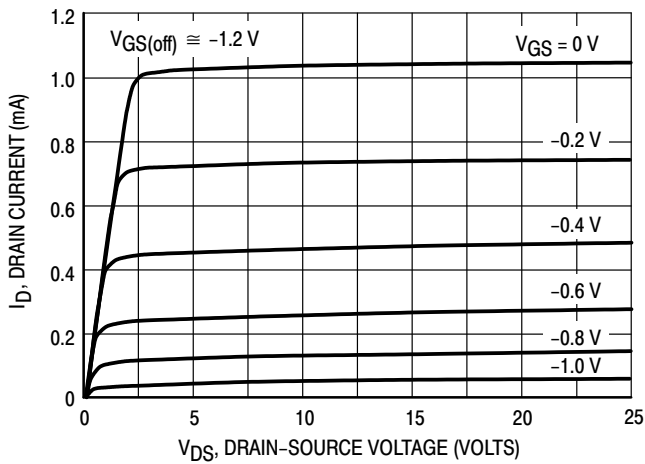

Figure 2. Typical Drain Characteristics

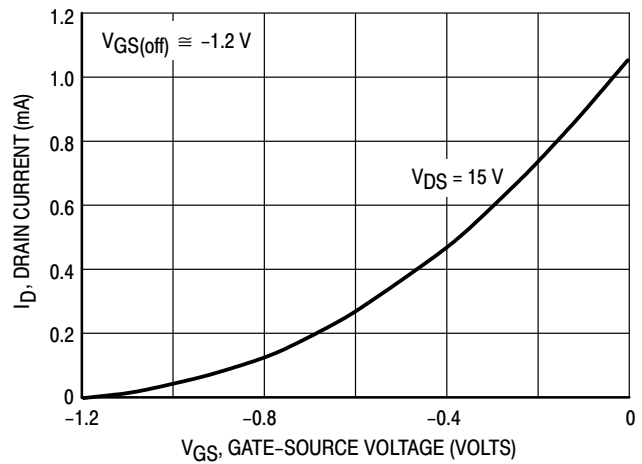

Figure 3. Common Source Transfer Characteristics

MMBF5457LT1

TYPICAL CHARACTERISTICS

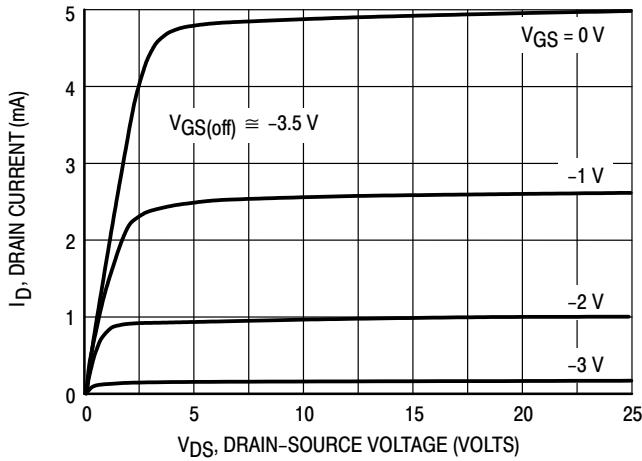

Figure 4. Typical Drain Characteristics

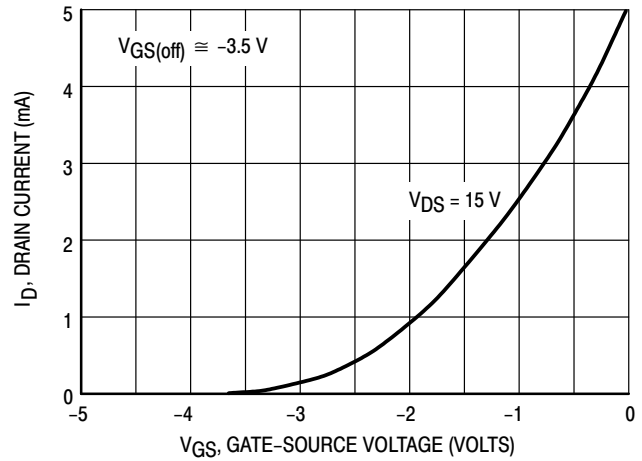

Figure 5. Common Source Transfer Characteristics

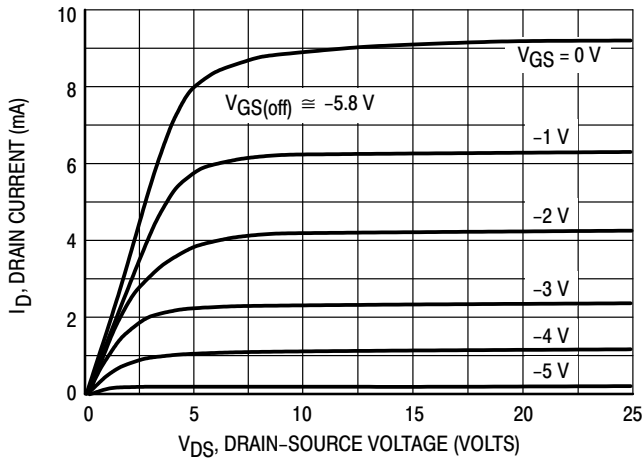

Figure 6. Typical Drain Characteristics

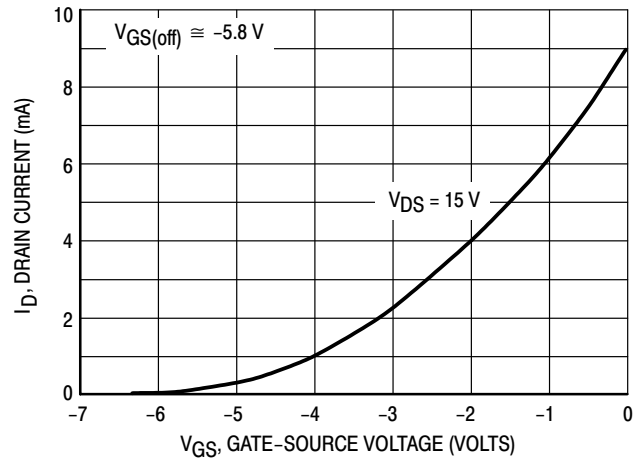

Figure 7. Common Source Transfer Characteristics

Note: Graphical data is presented for dc conditions. Tabular data is given for pulsed conditions (Pulse Width = 630 ms, Duty Cycle = 10%). Under dc conditions, self heating in higher I_{DSS} units reduces I_{DSS} .

INFORMATION FOR USING THE SOT-23 SURFACE MOUNT PACKAGE
MINIMUM RECOMMENDED FOOTPRINT FOR SURFACE MOUNTED APPLICATIONS

Surface mount board layout is a critical portion of the total design. The footprint for the semiconductor packages must be the correct size to insure proper solder connection

interface between the board and the package. With the correct pad geometry, the packages will self align when subjected to a solder reflow process.

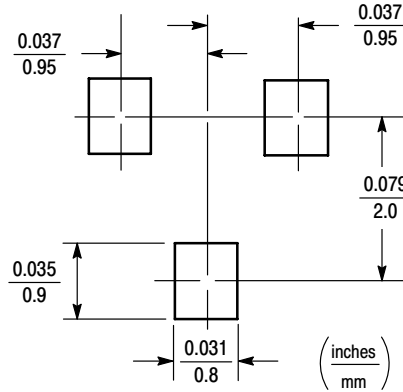

SOT-23

SOT-23 POWER DISSIPATION

The power dissipation of the SOT-23 is a function of the pad size. This can vary from the minimum pad size for soldering to a pad size given for maximum power dissipation. Power dissipation for a surface mount device is determined by $T_{J(max)}$, the maximum rated junction temperature of the die, $R_{\theta JA}$, the thermal resistance from the device junction to ambient, and the operating temperature, T_A . Using the values provided on the data sheet for the SOT-23 package, P_D can be calculated as follows:

$$P_D = \frac{T_{J(max)} - T_A}{R_{\theta JA}}$$

The values for the equation are found in the maximum ratings table on the data sheet. Substituting these values into the equation for an ambient temperature T_A of 25°C, one can calculate the power dissipation of the device which in this case is 225 milliwatts.

$$P_D = \frac{150^\circ\text{C} - 25^\circ\text{C}}{556^\circ\text{C/W}} = 225 \text{ milliwatts}$$

The 556°C/W for the SOT-23 package assumes the use of the recommended footprint on a glass epoxy printed circuit board to achieve a power dissipation of 225 milliwatts. There are other alternatives to achieving higher power dissipation from the SOT-23 package. Another alternative would be to use a ceramic substrate or an aluminum core board such as Thermal Clad™. Using a board material such as Thermal Clad, an aluminum core board, the power dissipation can be doubled using the same footprint.

SOLDERING PRECAUTIONS

The melting temperature of solder is higher than the rated temperature of the device. When the entire device is heated to a high temperature, failure to complete soldering within a short time could result in device failure. Therefore, the following items should always be observed in order to minimize the thermal stress to which the devices are subjected.

- Always preheat the device.
- The delta temperature between the preheat and soldering should be 100°C or less.*
- When preheating and soldering, the temperature of the leads and the case must not exceed the maximum temperature ratings as shown on the data sheet. When using infrared heating with the reflow soldering method, the difference shall be a maximum of 10°C.
- The soldering temperature and time shall not exceed 260°C for more than 10 seconds.
- When shifting from preheating to soldering, the maximum temperature gradient shall be 5°C or less.
- After soldering has been completed, the device should be allowed to cool naturally for at least three minutes. Gradual cooling should be used as the use of forced cooling will increase the temperature gradient and result in latent failure due to mechanical stress.
- Mechanical stress or shock should not be applied during cooling.

* Soldering a device without preheating can cause excessive thermal shock and stress which can result in damage to the device.

MMBF5457LT1

PACKAGE DIMENSIONS

SOT-23 (TO-236AB)
CASE 318-08
ISSUE AF

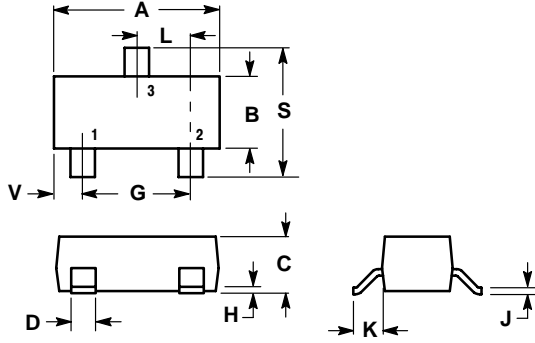

NOTES:

1. DIMENSIONING AND TOLERANCING PER ANSI Y14.5M, 1982.
2. CONTROLLING DIMENSION: INCH.
3. MAXIMUM LEAD THICKNESS INCLUDES LEAD FINISH THICKNESS. MINIMUM LEAD THICKNESS IS THE MINIMUM THICKNESS OF BASE MATERIAL.

DIM	INCHES		MILLIMETERS	
	MIN	MAX	MIN	MAX
A	0.1102	0.1197	2.80	3.04
B	0.0472	0.0551	1.20	1.40
C	0.0350	0.0440	0.89	1.11
D	0.0150	0.0200	0.37	0.50
G	0.0701	0.0807	1.78	2.04
H	0.0005	0.0040	0.013	0.100
J	0.0034	0.0070	0.085	0.177
K	0.0140	0.0285	0.35	0.69
L	0.0350	0.0401	0.89	1.02
S	0.0830	0.1039	2.10	2.64
V	0.0177	0.0236	0.45	0.60

STYLE 10:
PIN 1. DRAIN
2. SOURCE
3. GATE

Notes

Notes

Thermal Clad is a trademark of the Bergquist Company.

ON Semiconductor and  are trademarks of Semiconductor Components Industries, LLC (SCILLC). SCILLC reserves the right to make changes without further notice to any products herein. SCILLC makes no warranty, representation or guarantee regarding the suitability of its products for any particular purpose, nor does SCILLC assume any liability arising out of the application or use of any product or circuit, and specifically disclaims any and all liability, including without limitation special, consequential or incidental damages. "Typical" parameters which may be provided in SCILLC data sheets and/or specifications can and do vary in different applications and actual performance may vary over time. All operating parameters, including "Typicals" must be validated for each customer application by customer's technical experts. SCILLC does not convey any license under its patent rights nor the rights of others. SCILLC products are not designed, intended, or authorized for use as components in systems intended for surgical implant into the body, or other applications intended to support or sustain life, or for any other application in which the failure of the SCILLC product could create a situation where personal injury or death may occur. Should Buyer purchase or use SCILLC products for any such unintended or unauthorized application, Buyer shall indemnify and hold SCILLC and its officers, employees, subsidiaries, affiliates, and distributors harmless against all claims, costs, damages, and expenses, and reasonable attorney fees arising out of, directly or indirectly, any claim of personal injury or death associated with such unintended or unauthorized use, even if such claim alleges that SCILLC was negligent regarding the design or manufacture of the part. SCILLC is an Equal Opportunity/Affirmative Action Employer.

PUBLICATION ORDERING INFORMATION

Literature Fulfillment:

Literature Distribution Center for ON Semiconductor
P.O. Box 5163, Denver, Colorado 80217 USA
Phone: 303-675-2175 or 800-344-3860 Toll Free USA/Canada
Fax: 303-675-2176 or 800-344-3867 Toll Free USA/Canada
Email: ONlit@hibbertco.com

N. American Technical Support: 800-282-9855 Toll Free USA/Canada

JAPAN: ON Semiconductor, Japan Customer Focus Center
4-32-1 Nishi-Gotanda, Shinagawa-ku, Tokyo, Japan 141-0031
Phone: 81-3-5740-2700
Email: r14525@onsemi.com

ON Semiconductor Website: <http://onsemi.com>

For additional information, please contact your local Sales Representative.